

PYÖRÖ8 |

Pyöreä LED-profiili

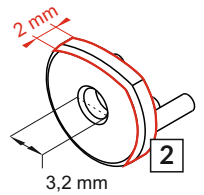
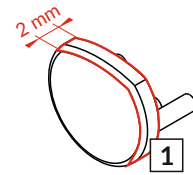
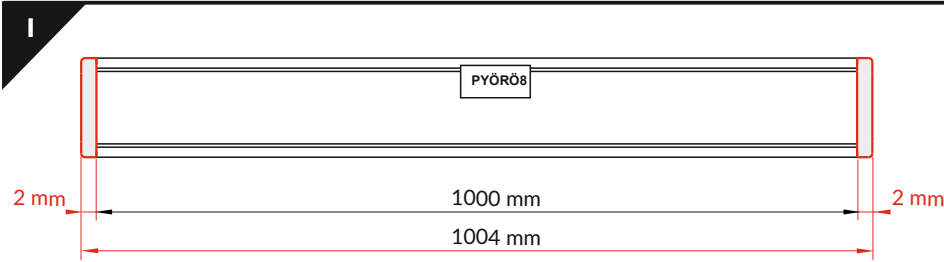
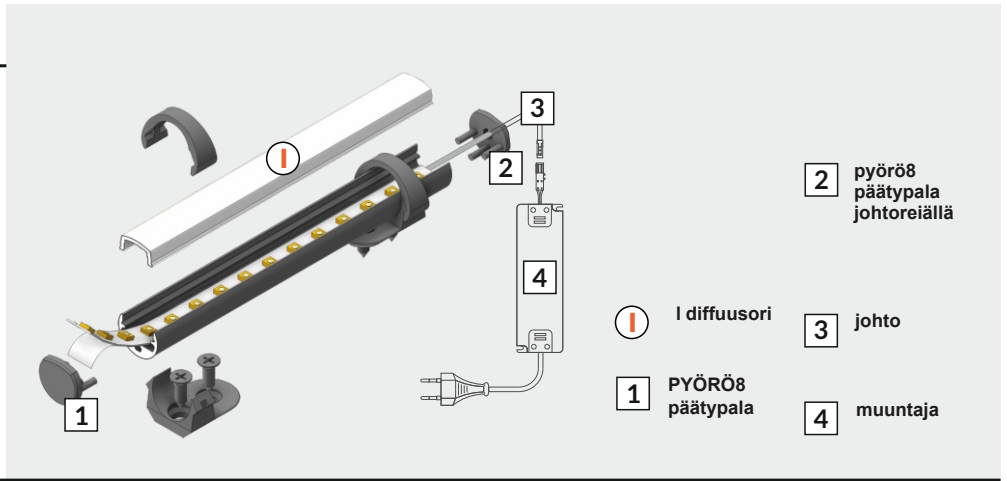
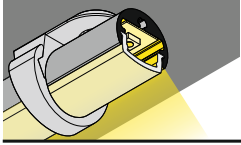
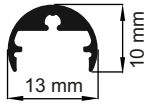

HUOM Päätykalat lisäävät profiilin pituutta 2mm

+ 2 x 2 mm).

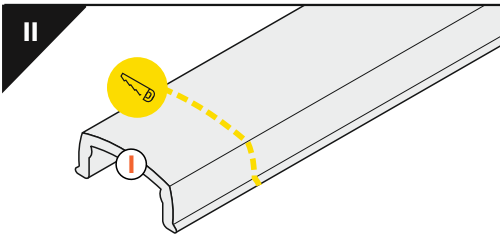

Kannen pituus on sama kuin profiilin pituus

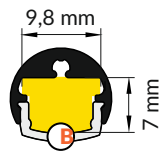
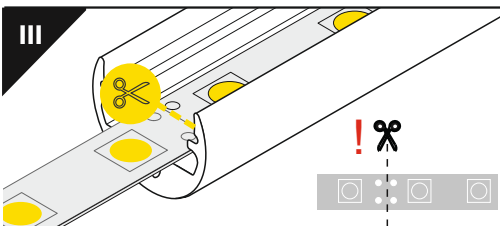

Profiilin asennusmitat upotusta varten

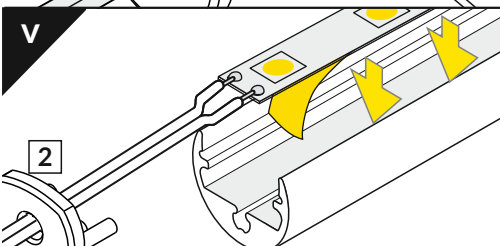
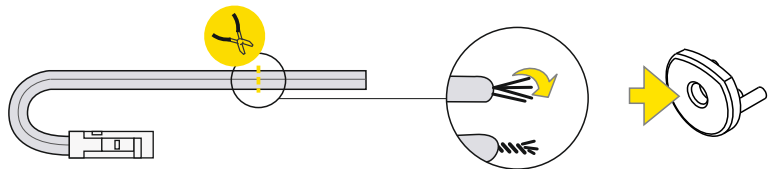
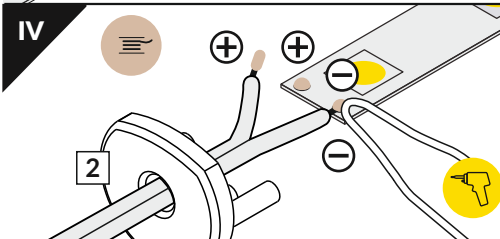

VI

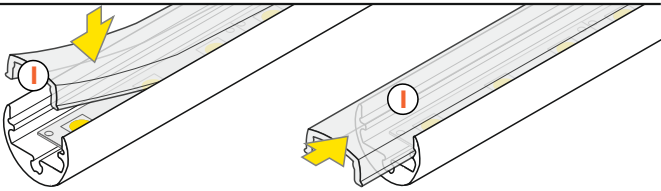

I DIFFUUSORI

VII ASENNUS

Sivu 2	PYÖRÖ8 päätykiinnikkeet
Sivu 2	PYÖRÖ8 rengaskiinnikkeet
Sivu 3	PYÖRÖ8 suorat seinäkiinnikkeet
Sivu 3	PYÖRÖ8 peruskiinnikkeet
Sivu 4	PYÖRÖ8 pidikkeet nivelellä, kierreasennettavat
Sivu 5	PYÖRÖ8 pidikkeet nivelellä, ruuviasennettavat
Sivu 6	PYÖRÖ8 tuplapidikkeet 90° kulmalla, kierreasennettavat
Sivu 7	PYÖRÖ8 tuplapidikkeet 90° kulmalla, ruuviasennettavat
Sivu 8	PYÖRÖ8 seinäkiinnike

PYÖRÖ8 päätykiinnikkeet

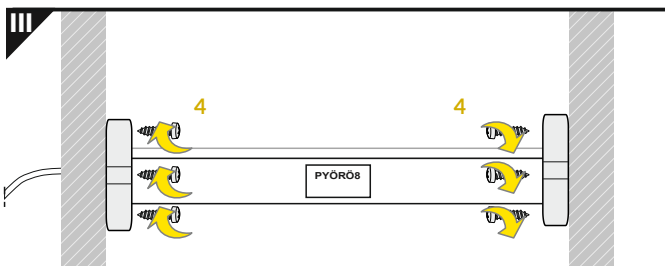
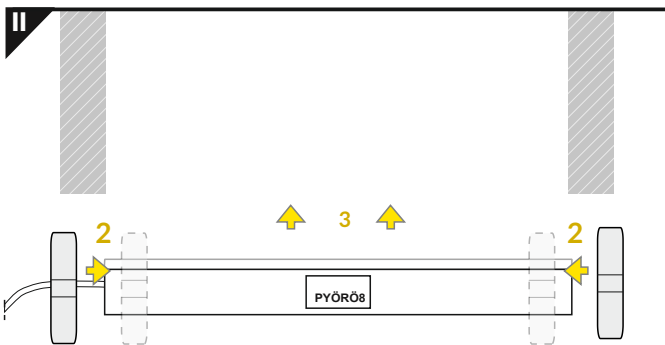
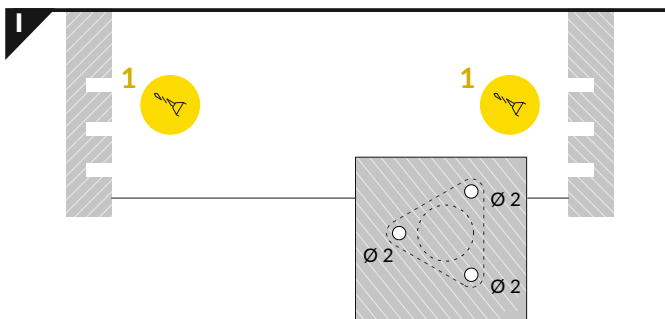

PYÖRÖ8 rengaskiinnikkeet

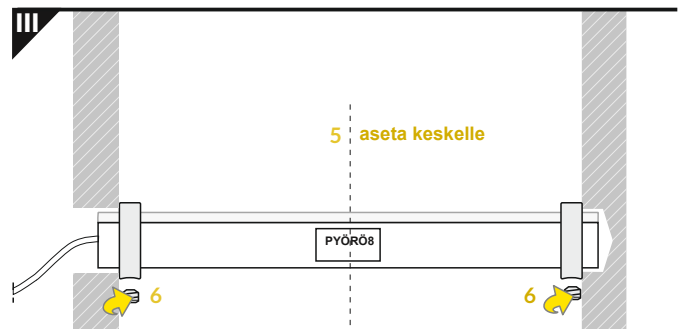
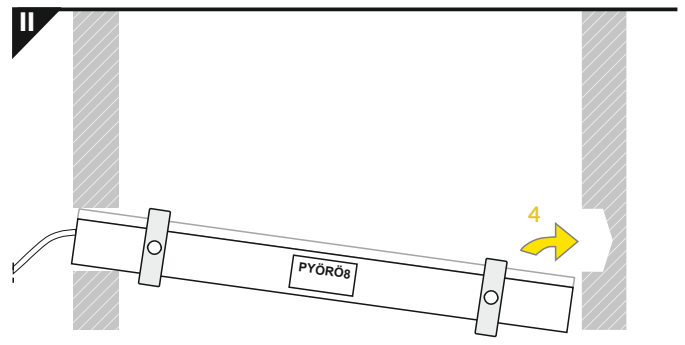
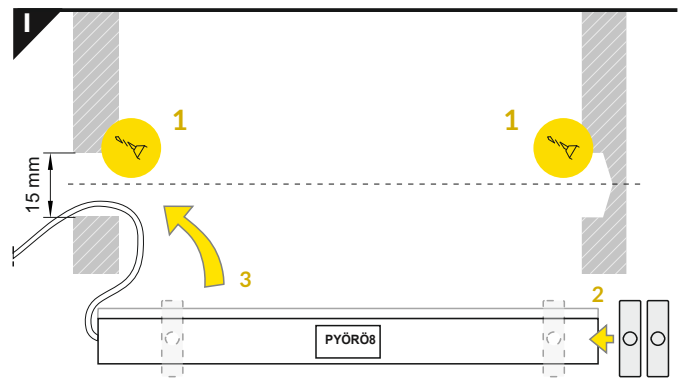

PYÖRÖ8 peruskiinnikkeet

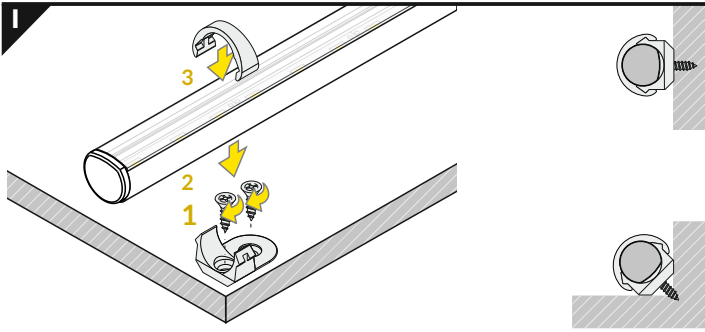

PYÖRÖ8 suorat seinäkiinnikkeet

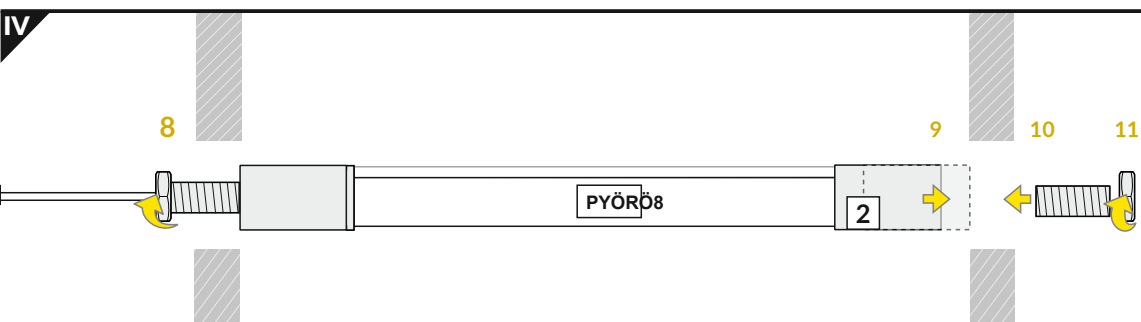
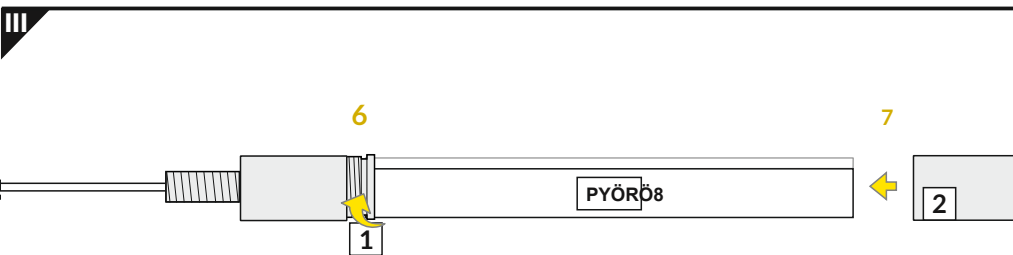
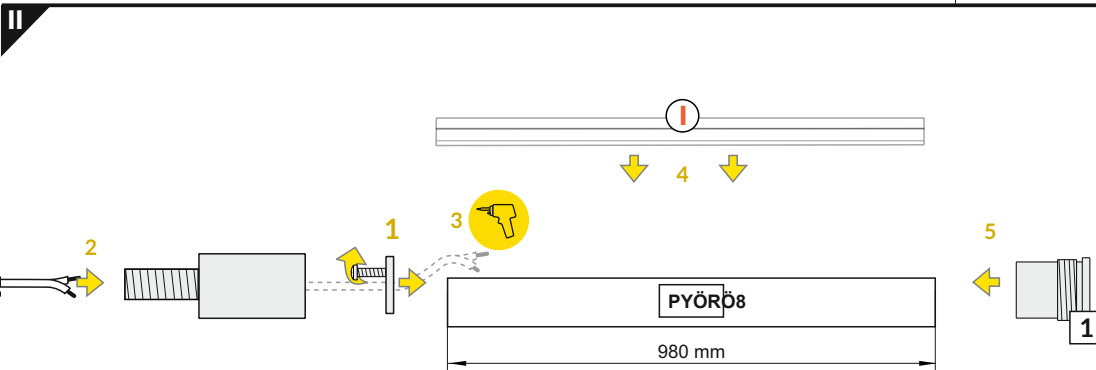
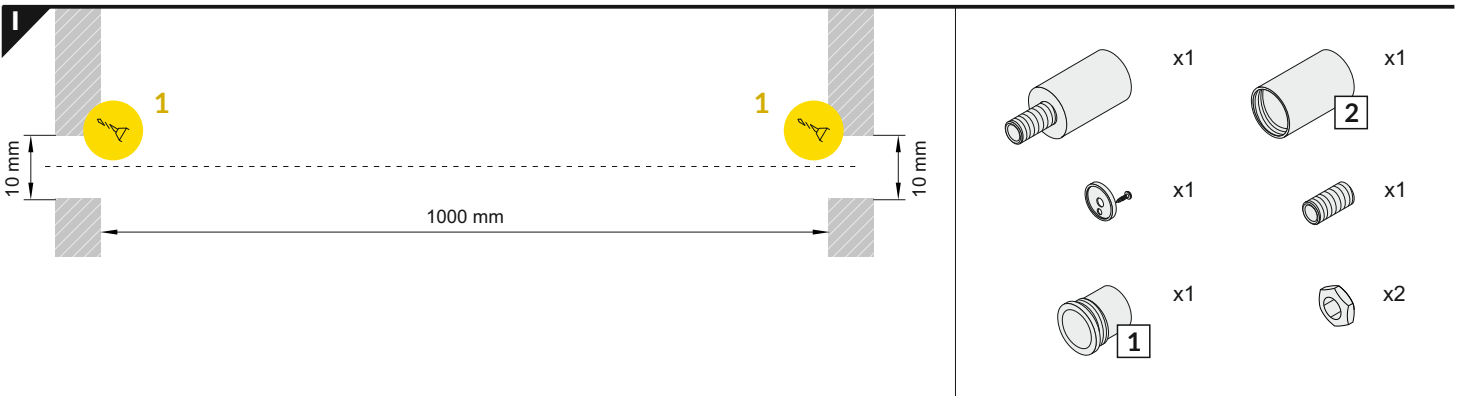

PYÖRÖ8 pidikkeet nivelellä, kierreasennettavat

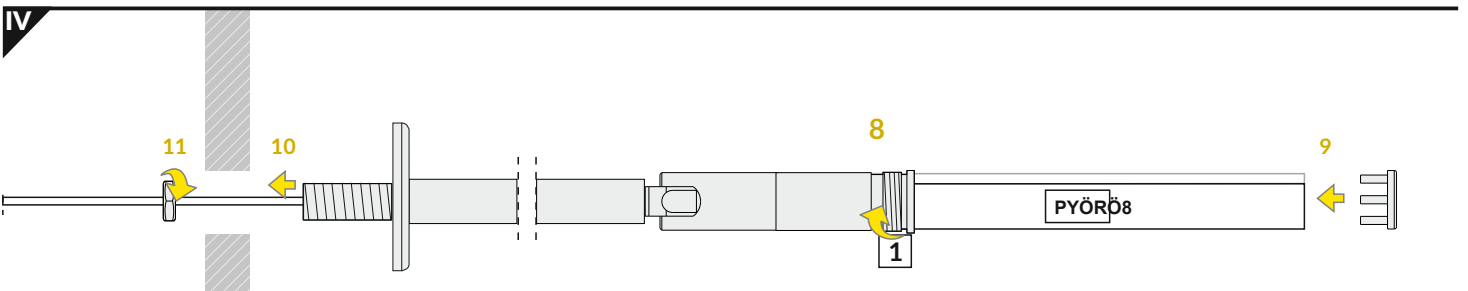
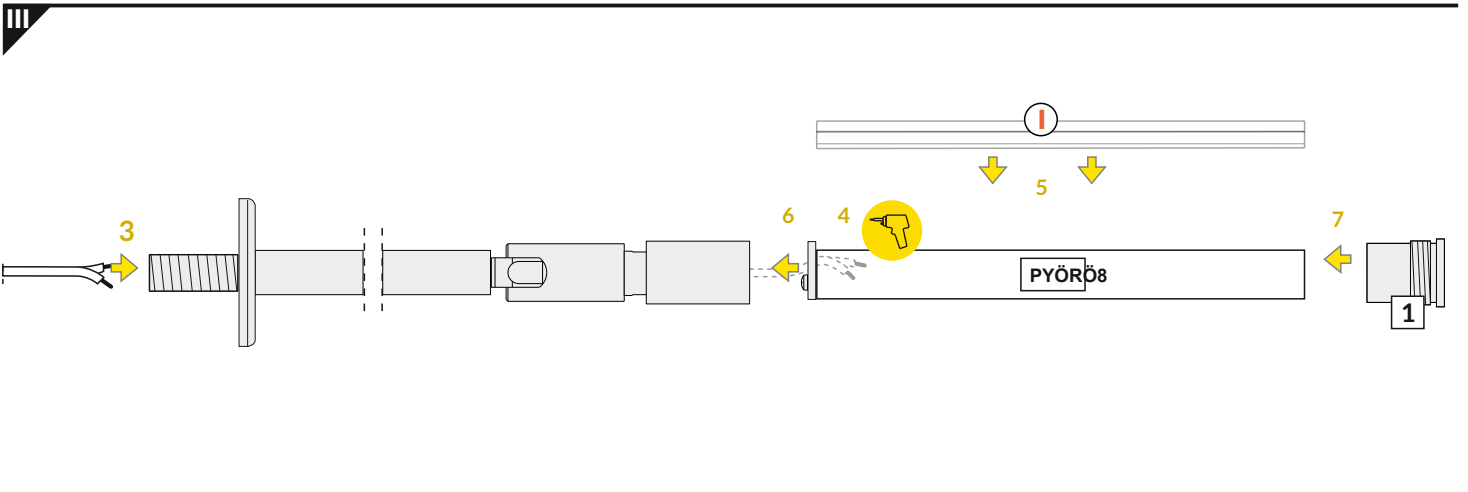
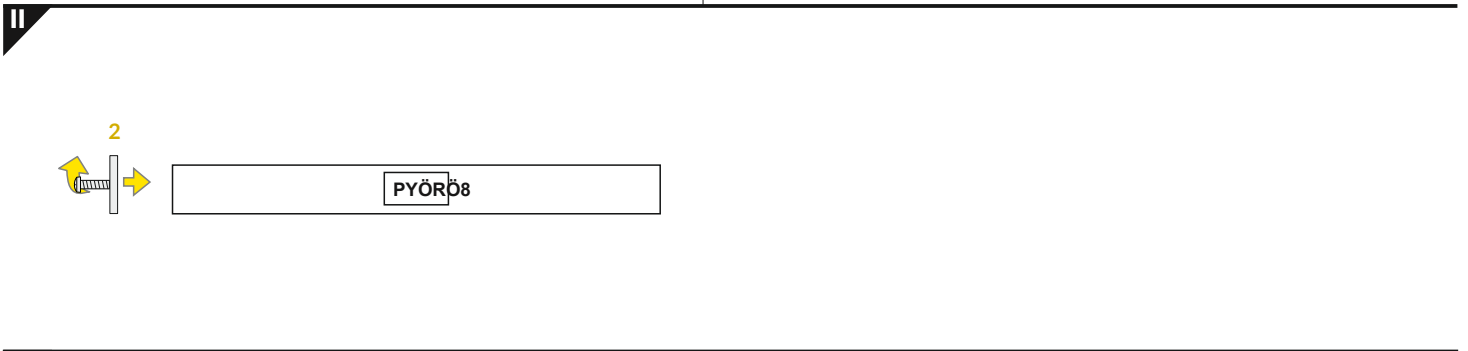
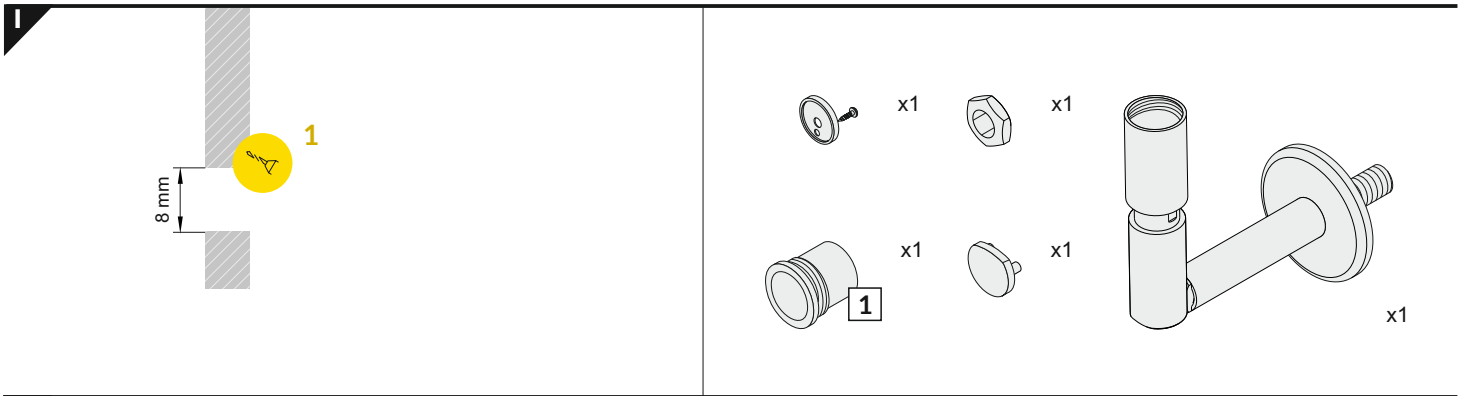

PYÖRÖ8 pidikkeet nivelellä, ruuviasennettavat

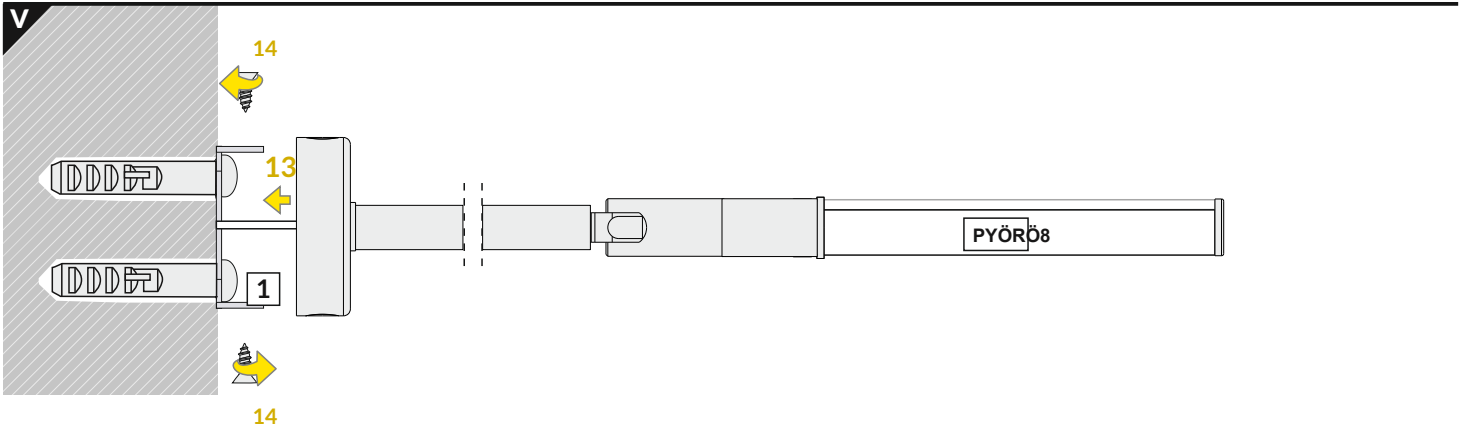
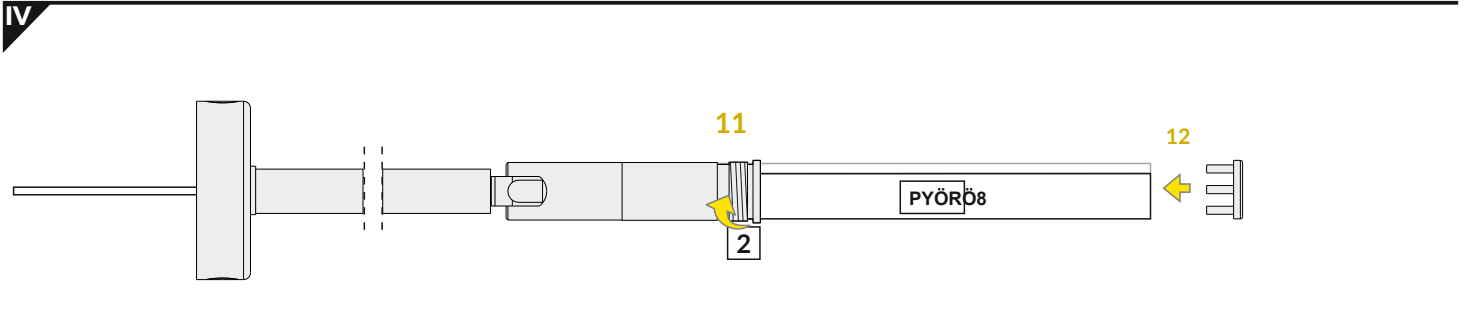
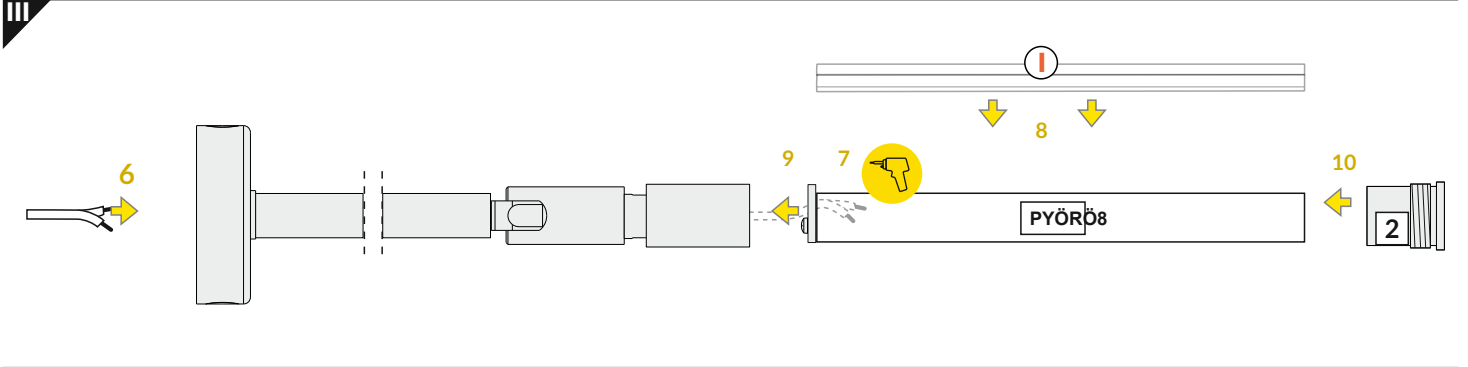
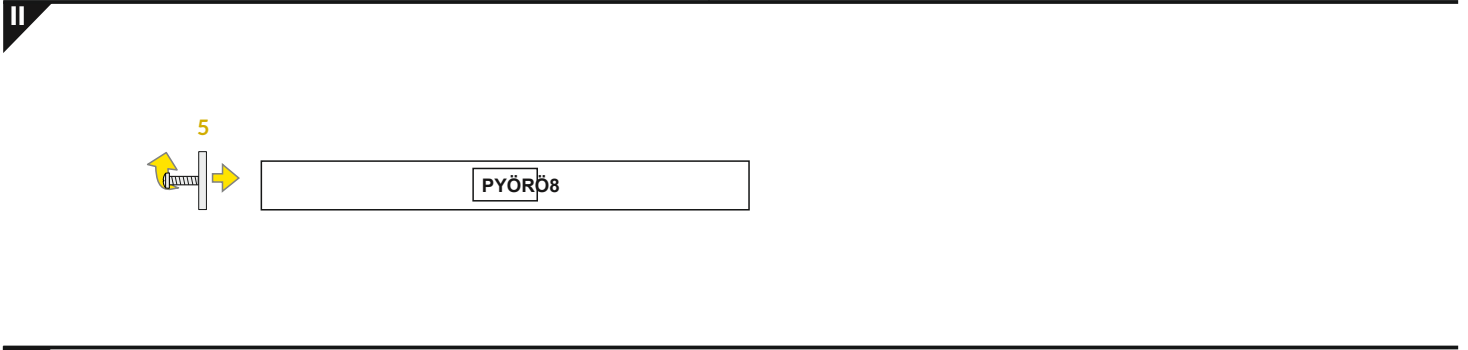
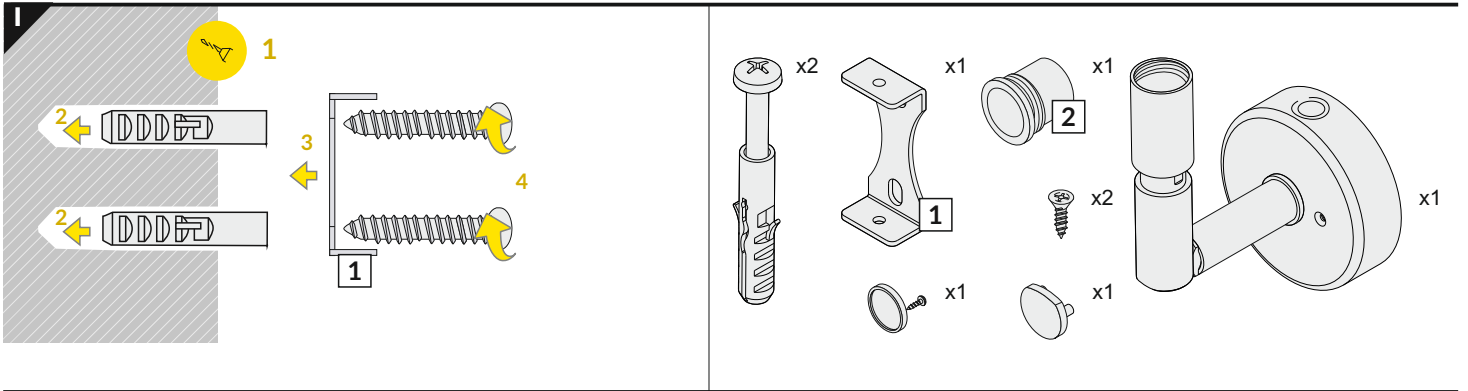

PYÖRÖ8 tuplapidikkeet 90° kulmalla, kierreasennettavat

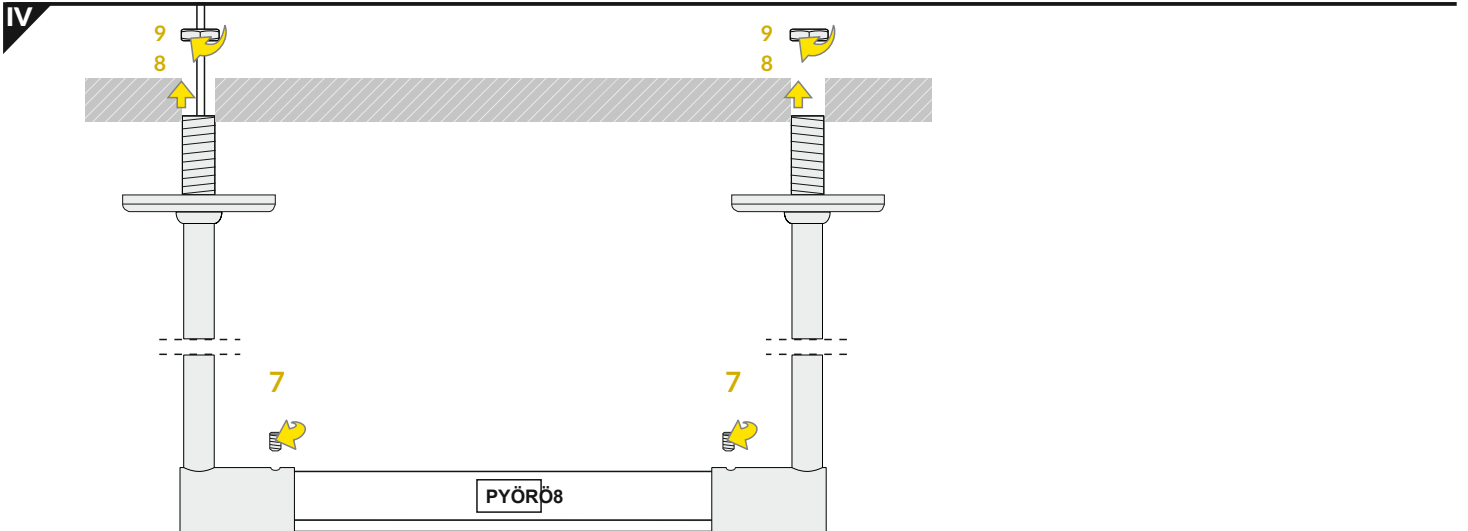
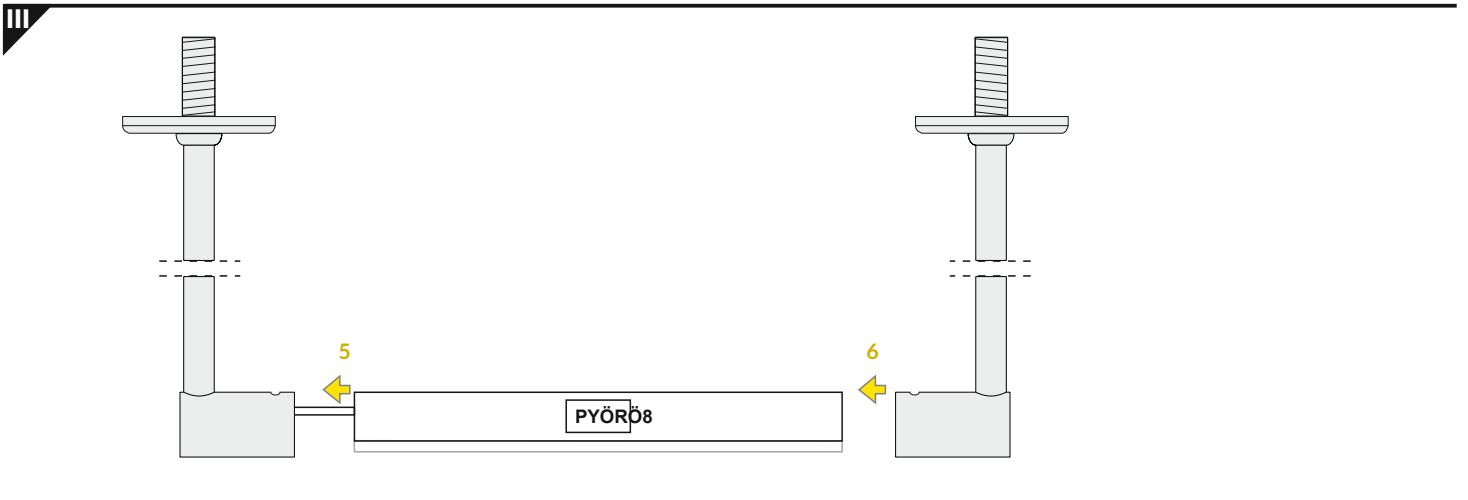
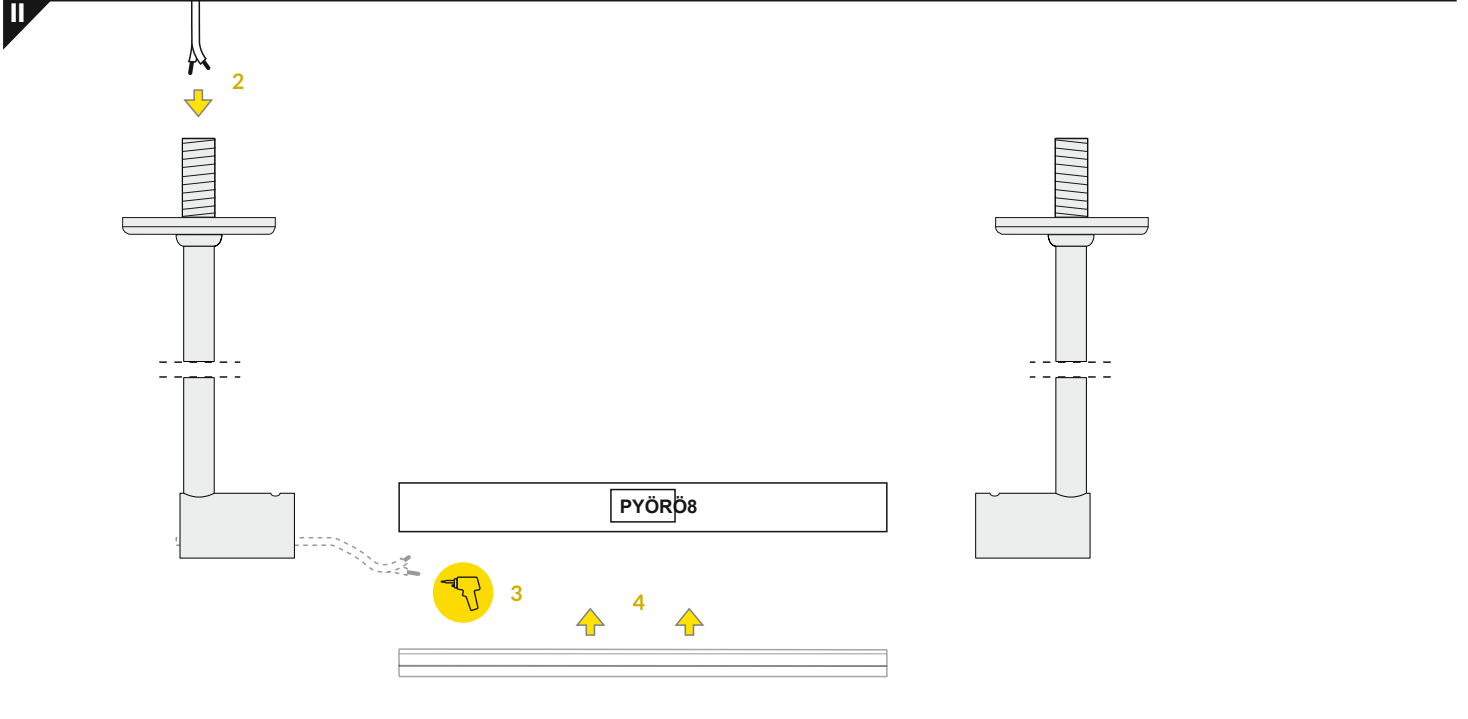
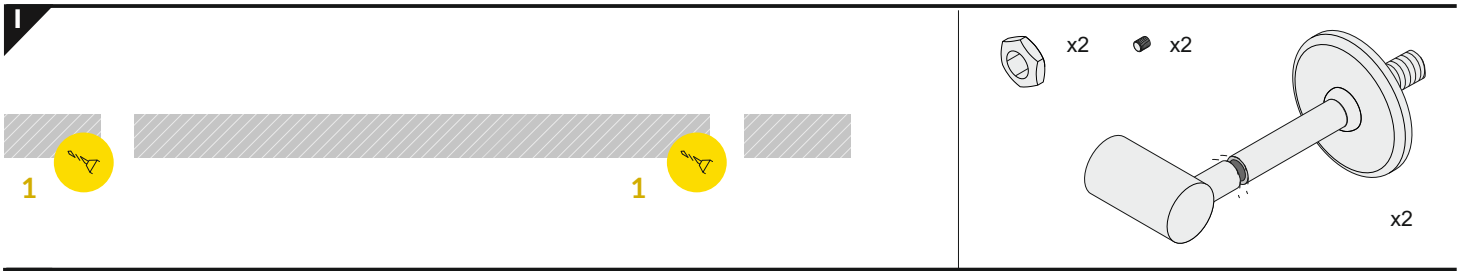

PYÖRÖ8 tuplapidikkeet 90° kulmalla, ruuviasennettävät

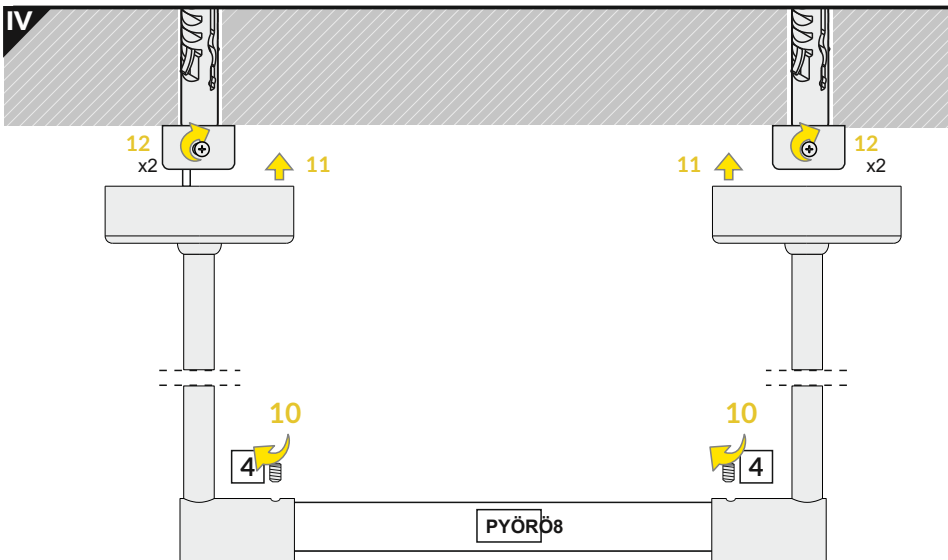
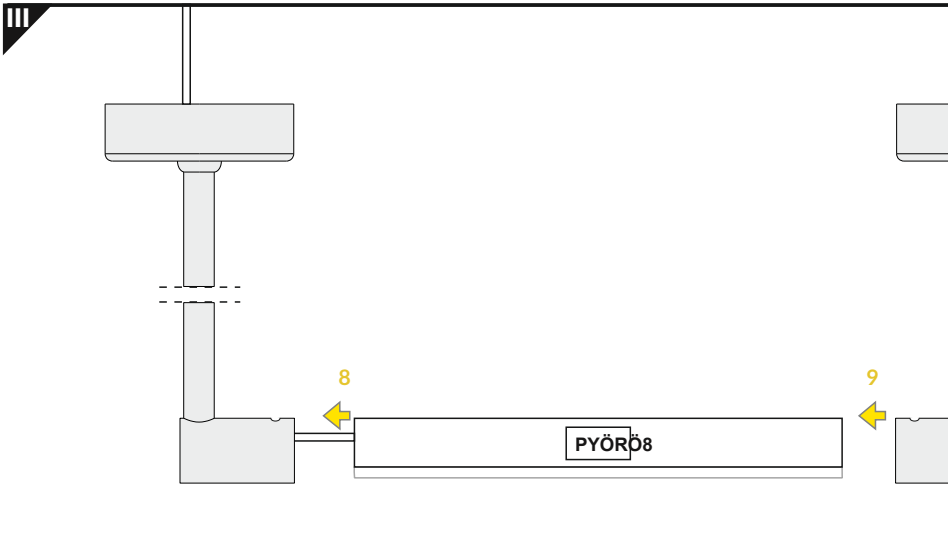
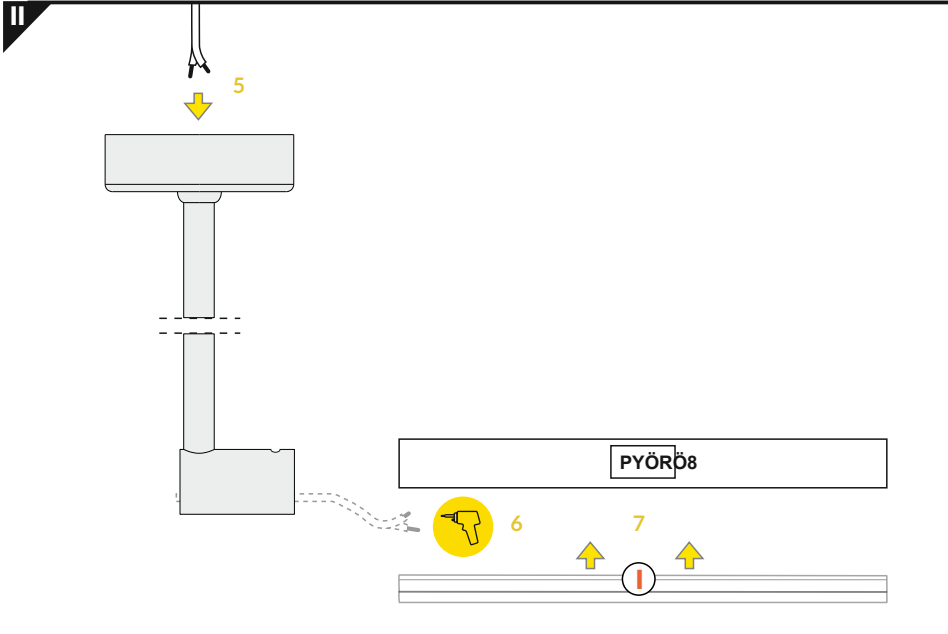
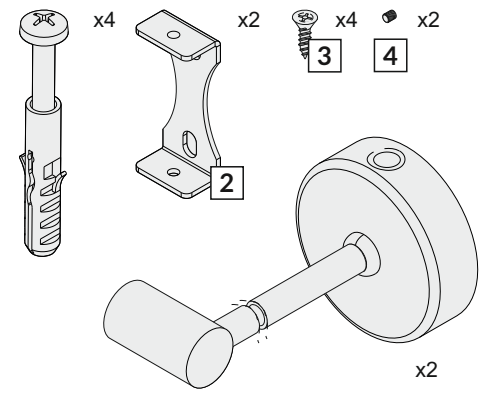
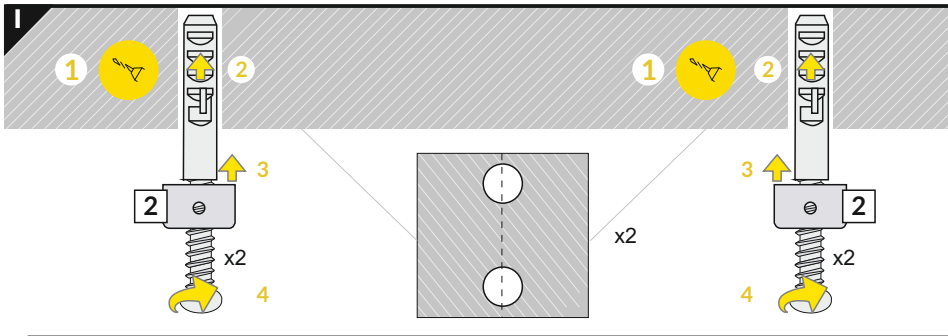

PYÖRÖ8 seinäkiinnike

